

FCI4400

Cellular Intercom 4G

 4G
LTE Ready

 AT&T
Preferred!



**DO NOT GIVE TO HOME OWNER
FOR PROFESSIONAL USE ONLY**

FAAC International Inc.
Headquarter & East Coast Operations
3160 Murrell Rd
Rockledge, FL 32955
Tel. 800 221 8278
www.faacusa.com

FAAC International Inc.
West Coast Operations
357 South Acacia Avenue
Fullerton, CA 92831

FAAC

Really important things you need to know	3
A look around the product	4
Overview of inside	4
Pedestal Installation	5
Power Module in detail	6
Cellular module in detail	6
Wiring relays	7
Keypad/prox module in detail	7
Connecting slave devices	8
Inserting the SIM	8
Powering up and LEDs	9
Installing the programmer APP for the first time	9
Programming a brand new install	11
Programming an existing install	11
Programming main steps	12
Additional Features	15
Keypad codes	16
Prox cards (optional models only)	17
Auto opening/closing	20
App control of gates	21
Do not disturb	21
After hours calling	22
Programming codes	22
Ringing times	23
Volumes	23
Information	24
Relay times	25
Complete list of parameters	25
Troubleshooting	28

Really Important things you Need to Know..



1 Please read this entire manual before installing this product.



2 To be installed by certified and qualified personnel / gate automation dealer only. Not for DIY install!



3 Ensure there is good At&T or T-Mobile 4G signal at the gate/door of the install site **BEFORE** installing this product. (This unit will also fall back to 3G service in some locations depending on network).



4 Set up on a bench in workshop **BEFORE** going to site. Program the unit in the comfort of your work bench and call technical support should you have questions.

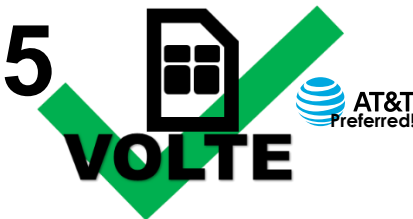

5 This product requires a SIM card from either At&T or T-Mobile, however **T-Mobile may not have matching band coverage in your area!** The SIM should be a voice and text plan. Do not use a DATA only SIM. Ensure your SIM has VOLTE (HD Voice calling service is enabled).



6 Manufacturer warranty does NOT cover lightning / storm damage. You **MUST** fit external surge protection and lightning rod in order to maintain warranty on this product. Evidence of surge protection will be requested on generation of RGA numbers.

Now lets have a look around the product...

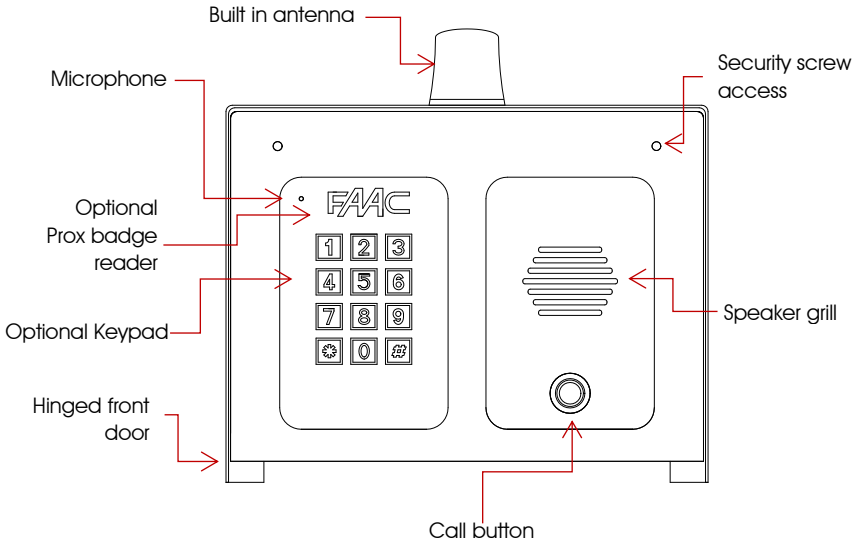

Overview of Inside...

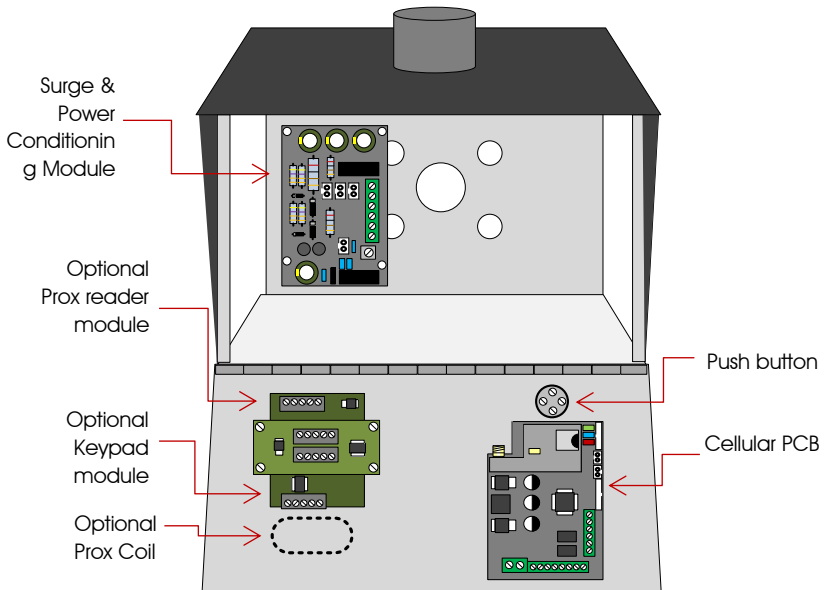

Pedestal Installation

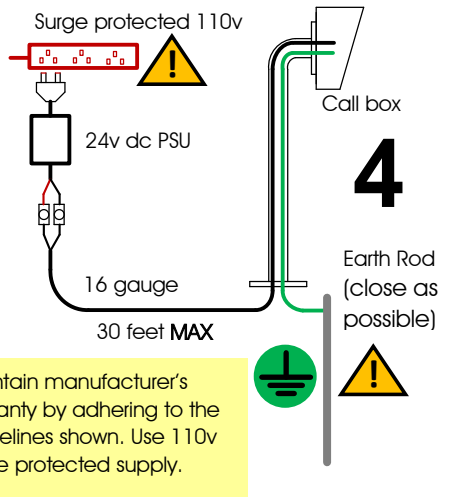
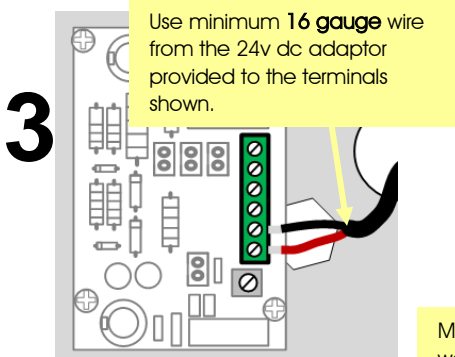
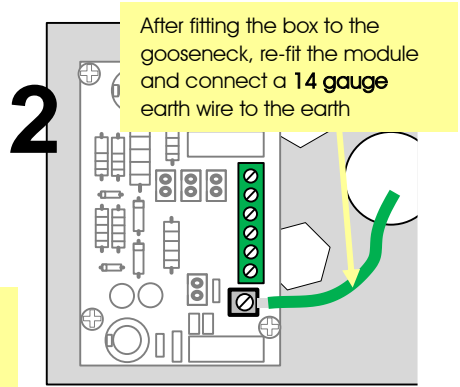
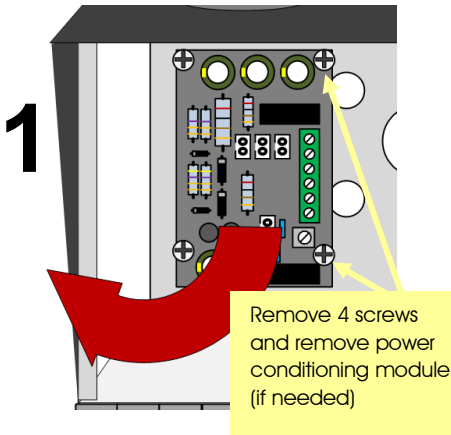

Power Module in Detail...

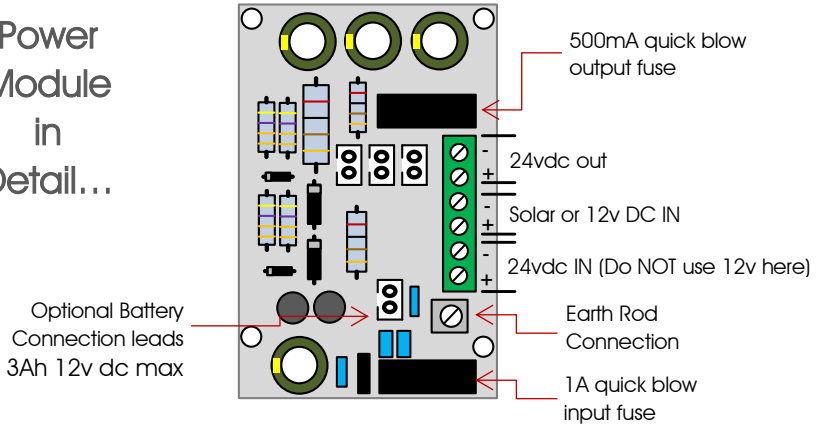

Cellular Module in Detail...

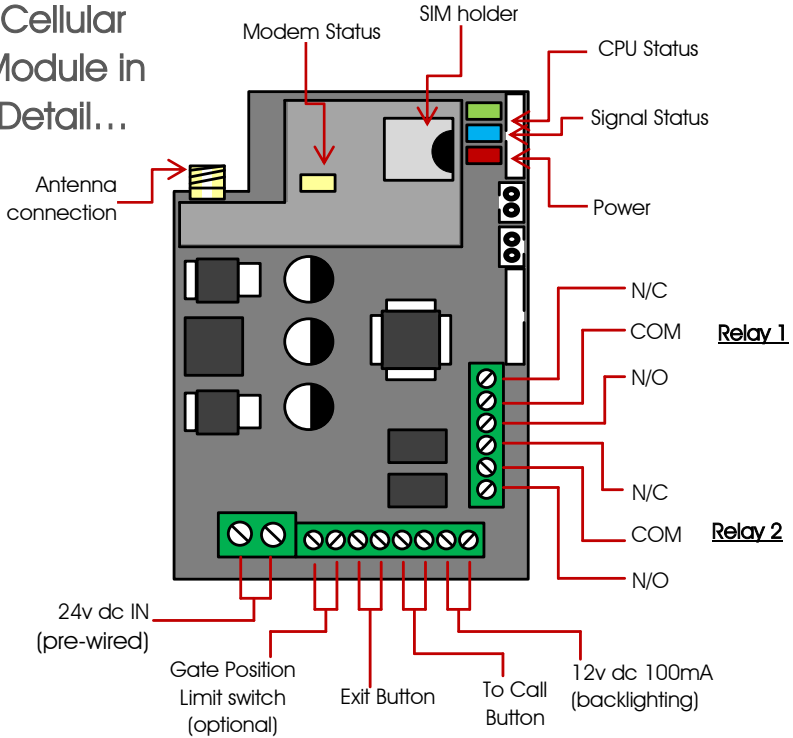

Wiring
Relays

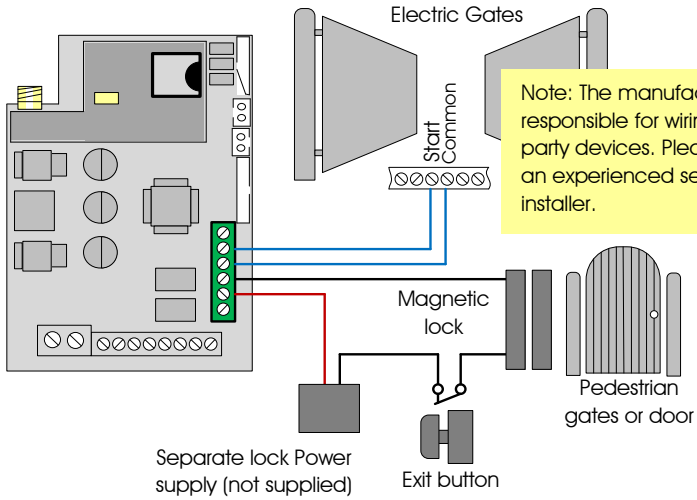

Keypad /
PROX
Modules in
Detail...

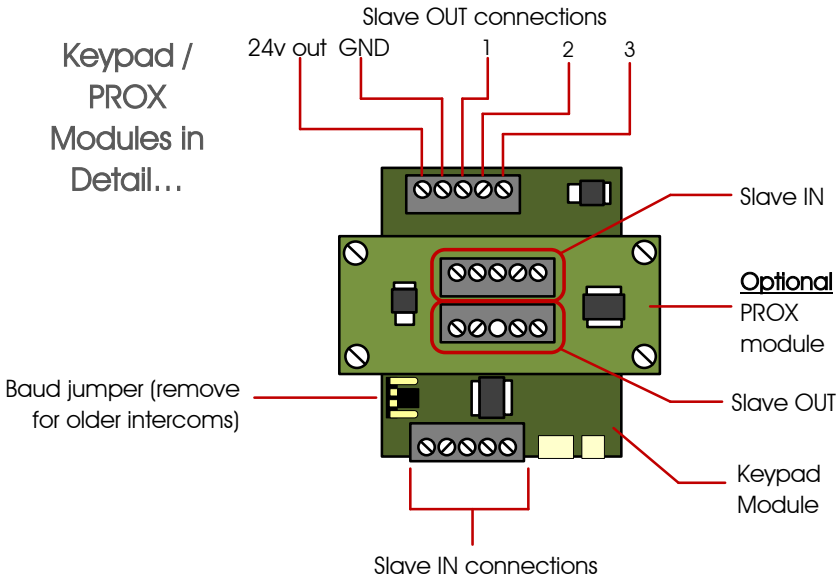

Connecting Slave Devices

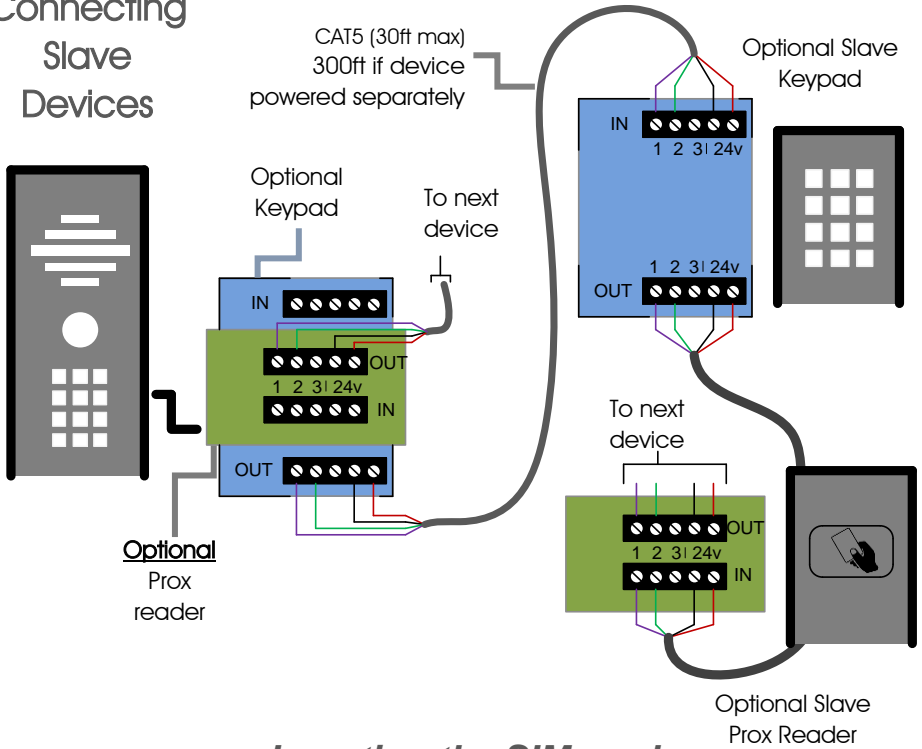

Inserting the SIM card

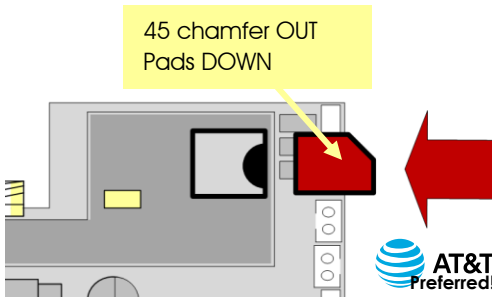

Ensure SIM is activated.
Pre-pay SIM will need credit first.
At&T preferred. T-Mobile also
compatible in certain areas.

WARNING

Ensure power is OFF. Do not hot
insert or remove while power on.

Powering Up & LEDs

Perform a final check of wiring and ensure the antenna is connected before switching on the power. Once the power is switched on, the power LED should illuminate.

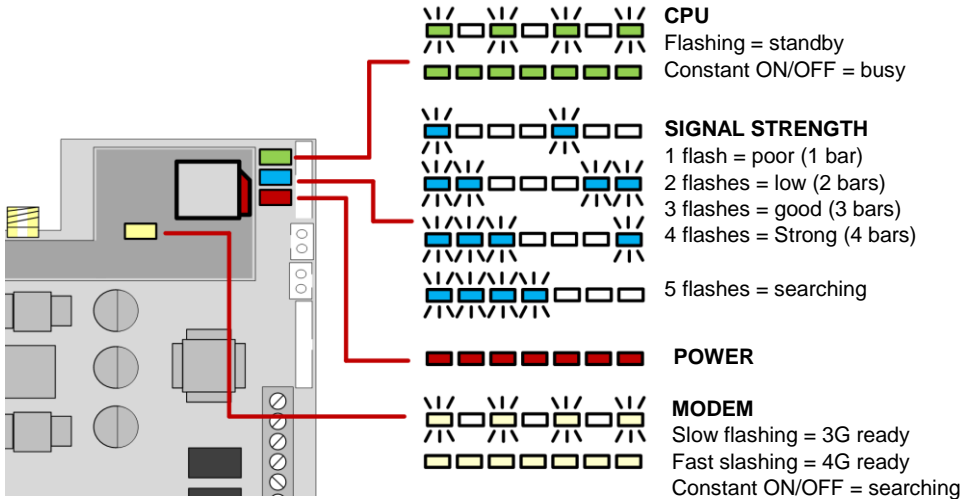

Installing the Programmer APP for the first time

If you are using an Apple or Android smart phone, download and install the FAAC Cell Access Pro APP. It will make programming much easier.



Note: You may notice the app "Cell Access" on the store. This is for homeowners to use.



Accept and allow all permissions (Android version shown)

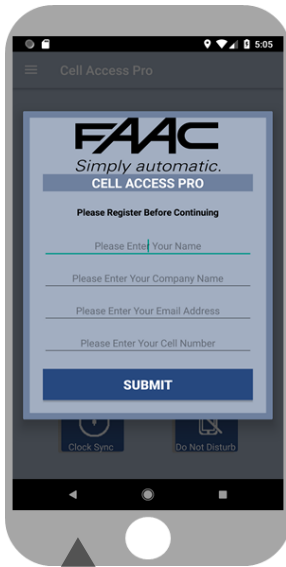

To register first time, enter your name, email and cell phone



After you send the registration email, go back to the app

Programming a Brand-New Install



Enter site or customer name, and INTERCOM PHONE NUMBER
 If Engineers and user pass codes are at default then do not change these. Once completed, you are ready to begin programming.

Programming an EXISTING Install



Now you are ready to begin programming!

Programming

Now that you have either entered a new client, or selected an existing client from the client list, you are now ready to begin programming.



Step 1A: Check Reception

Go to MORE>INFO to reveal the screen shown. Press the reception check button. On Android the app will automatically send a SMS string (*20#) to the intercom.

On iPhone, users will be taken to their SMS screen to confirm before sending the string.

The intercom should reply with a signal level between 1 & 31.

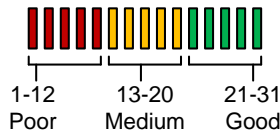

For good performance, signal level should be at least 13 or better.

TIP: If signal is lower than recommended, then take IMMEDIATE action. Change network if possible, or use an optional high gain antenna. Check power cable is within recommended specification. (Poor power cable can lower reception).

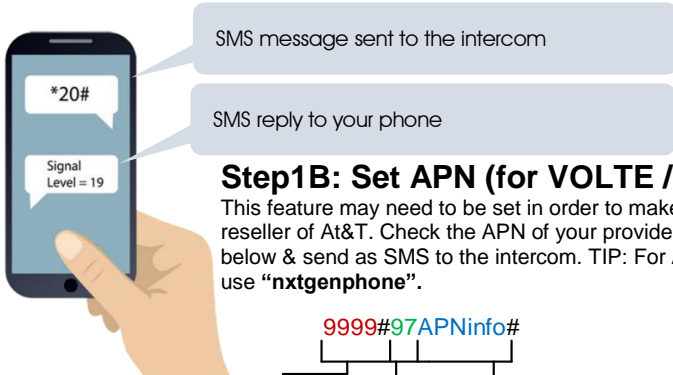

Step1B: Set APN (for VOLTE / 4G voice calling)

This feature may need to be set in order to make 4G voice calls with At&T a reseller of At&T. Check the APN of your provider, enter it in the blue section below & send as SMS to the intercom. TIP: For At&T cards from At&T store use "nxtgenphone".

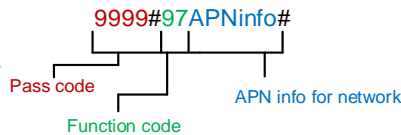

Step1C: Reboot the Intercom

The intercom will need to be rebooted in order to log on to the network with the new APN which you have stored. If you send another reception check (*20#), you may find that if it was on 3G signal strength before, that it is now on 4G signal.

Step2: Activate Clock Sync

This feature makes the intercom send itself a SMS after a power failure.

This feature must be activated to maintain proper time (the intercom re-calibrates its time from an incoming SMS message).

SMS Programming Format:

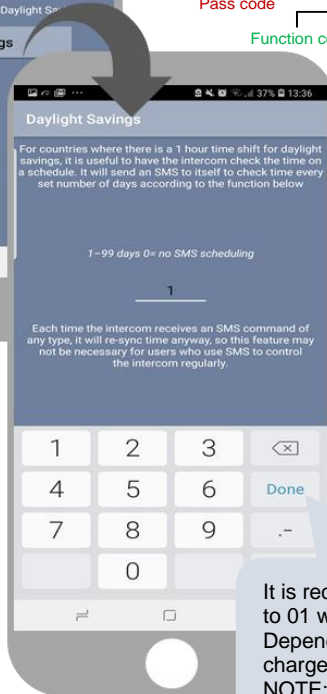
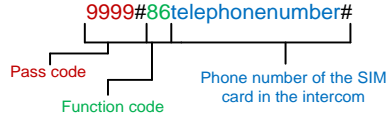

Step 3: Activate Daily Activity

This feature is needed for 2 reasons:

1. To prevent some cellular carriers disconnecting the 4G LTE due to inactivity on the device.
2. To keep time synchronisation in regions where there are summer daylight saving time changes.

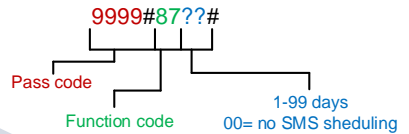

It is recommended to set the number of days to 01 which will send SMS every day.

Depending on carrier provider, this may be chargeable to the customer.

NOTE: Must be 2 characters, e.g. 01, 02 etc.



Step4: Programming Numbers for the intercom to call

1. Press the SINGLE home icon for a 1 button system, or MULTI for a 10 button system.
2. Simply enter cell phone numbers and/or landline phones which the intercom is to call when the call button is pressed. (10 button model please enter button number).
3. Press SAVE. Note: iphone users will be taken to their SMS screen to confirm the SMS string (press send).
4. The intercom should reply with an SMS to your phone showing the SMS string and an OK status.

SMS Programming Format:

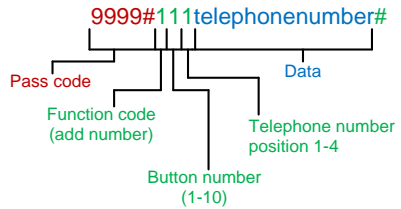

Step5: Programming Caller ID access numbers (100 max).

1. Simply enter cell phone numbers of visitors whom should have access with caller ID (up to 4 at a time).
2. Press SAVE. Note: iphone users will be taken to their SMS screen to confirm the SMS string (press send).
3. The intercom should reply with an SMS to your phone showing the SMS string and an OK status.

SMS Programming Format:

9999#72telephonenumber#72telephonenumber#72telephonenumber#72telephonenumber#

To delete a number:

9999#73telephonenumber#

To delete all numbers:

9999#73*#

Additional Features

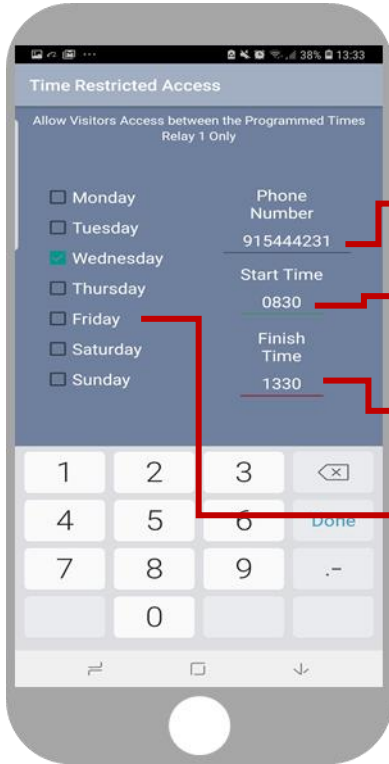

Time restricted Caller ID (20 users)

Enter phone number of visitor

Enter start time in 24hr format (military style) with no colon. E.g. 8,30am = 0830

Enter end time in 24hr format (military style) with no colon. E.g. 1.30pm = 1330

Select the days which access are to be granted

SMS string for time restricted caller ID:

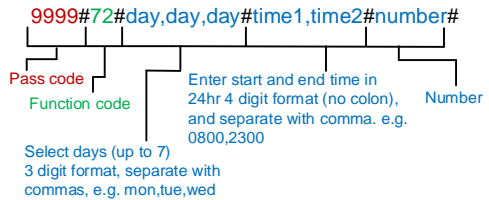

To delete a number:

9999#73telephonenumber#

To delete all numbers:

9999#73*#

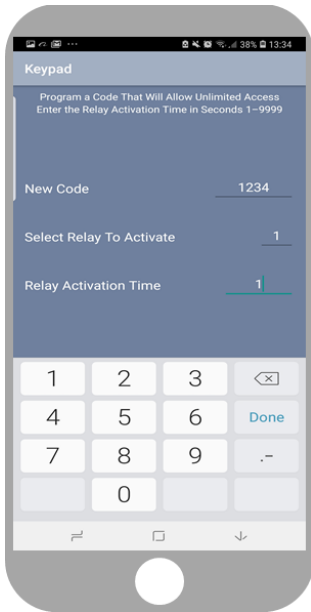

Permanent Keypad Code

Stores up to 200 codes, all of which can be used to gain access 24/7.

Enter a 4 digit code

Choose relay 1 or relay 2 (pedestrian option)

1 second for gate systems or strike lock, 3-10 seconds for magnetic locks. Can also enter longer time for holding gates open for a pre-defined period.

SMS String for adding keypad codes:

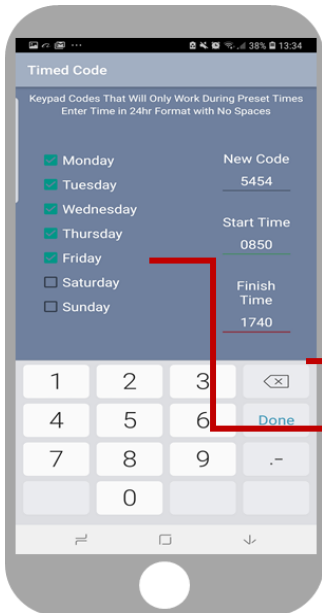
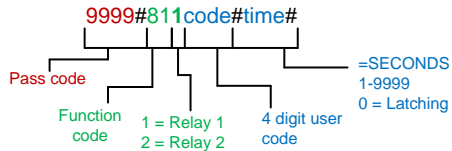

Time Restricted Code

Stores up to 20 codes which can be restricted to pre-set times and days of the week. (Relay 1 only).

Enter a 4 digit code

Enter start time in 24hr format (military style) with no colon. E.g. 8.30am = 0830

Enter end time in 24hr format (military style) with no colon. E.g. 1.30pm = 1330

Select the days which access are to be granted

SMS String for adding keypad codes:

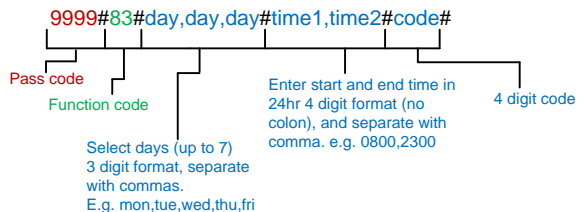

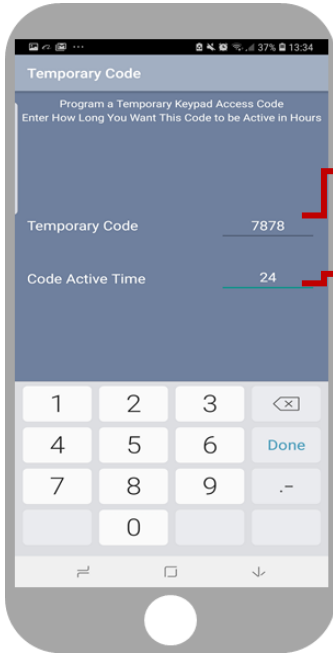

Temporary Code

Stores up to 30 codes which will auto expire after the pre-set time has elapsed.

Enter a 4 digit code

Enter time in hrs (1-168)

SMS String for temporary code:

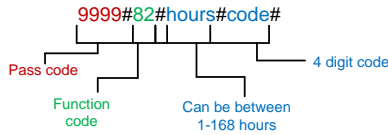

Proximity Cards (Optional)

Cards can be added by serial number printed on the card. There are 3 types of card stored.

Ensure to select your correct intercom model. (4G models can store a name against each card for reference).

Time restricted Prox cards (cards that will only work during pre-set times and days of the week)

Temporary Prox cards which auto expire in a pre-se time.

Check stored Prox cards. Intercom will reply with SMS message.

Only on selected models!

24/7 cards

Enter card users name (6 digits max)

Enter card serial number (10 digits)



Choose relay 1 or relay 2 for activation

1 sec for gates or strike lock. 5-10 secs for mag lock. 0 = latching

SMS String for adding Prox cards/tags:

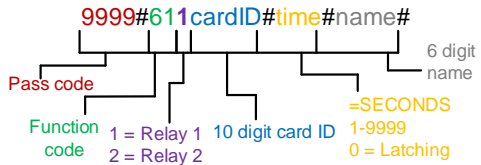

Only on selected models!

Time Restricted Prox Cards

Store up to 20 cards which only work during pre-set days and times of the week. (Relay 1 only).

Enter card ID (10 digits)



Enter start time in 24hr format (military style) with no colon. E.g. 8.30am = 0830

Enter end time in 24hr format (military style) with no colon. E.g. 1.30pm = 1330

Select the days which access are to be granted

Only on selected models!

SMS String for time restricted card/tag:

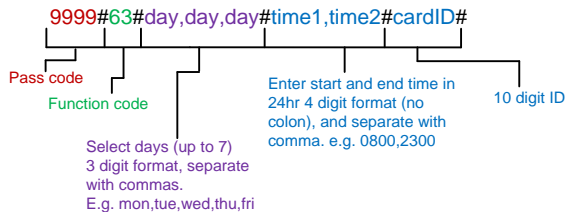

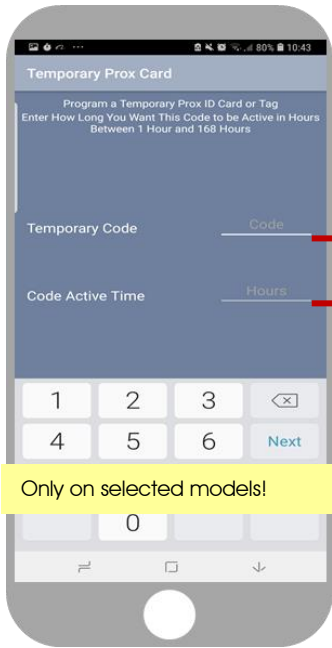

Auto Expiring Temp Cards

Store up to 30 cards which auto expire within a certain time frame. (Relay 1 only).

Enter card ID (10 digits)



Enter countdown time in hours (1-168)

SMS String for temporary card/tag:

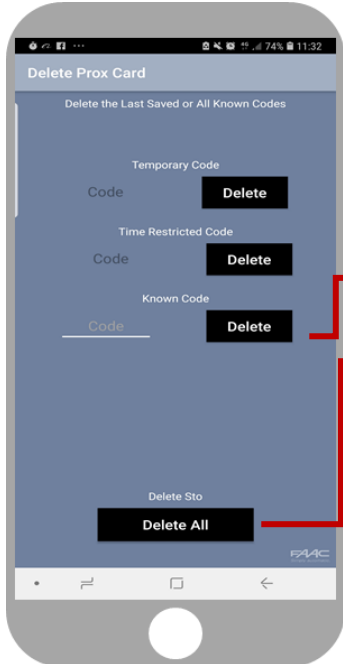
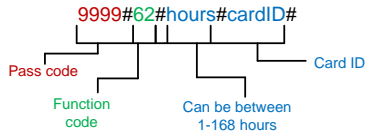

Deleting cards

This screen allows any known card ID to be deleted (by serial number), and it will also show the last stored cards for each type of card.

Enter known card ID (10 digits)



Delete all stored cards and start again.

SMS String for deleting a known card:

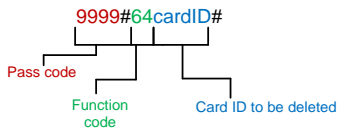

Deleting ALL cards: 9999#64*#



Automatic Open/close

Set up to 20 auto trigger, latch or unlatch times to control gates, depending on the setup of the gate system
 For step-by-step setup, use trigger times to open or close gates as required.
 For auto-closing gates, use latching and unlatching commands to control open times

1. Pick the event
2. Enter time in 24hr format, no colon.
3. Select the days required.

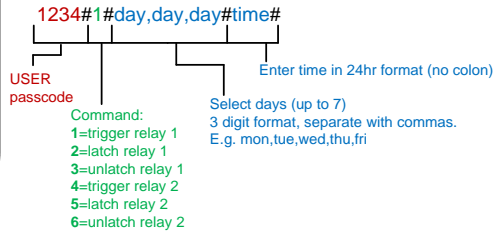

App Control of Gates

Gates can be controlled from the APP. Take care not to use the LATCH command with a strike lock as it can cause damage to the lock.

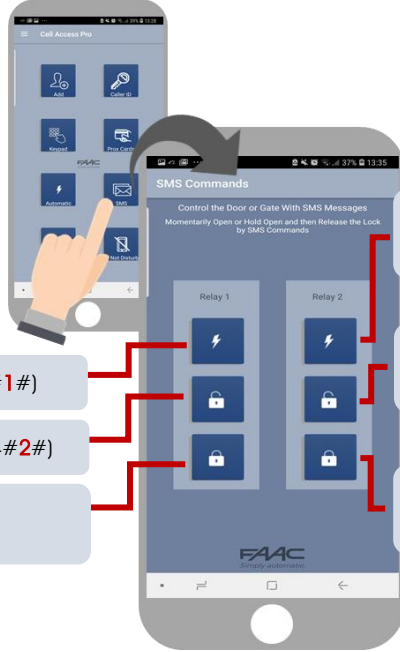

- Relay 1 – Momentary (1234#1#)
- Relay 1 – Latch / HOLD (1234#2#)
- Relay 1 – Unlatch / UNHOLD (1234#3#)

- Relay 2 – Momentary (1234#4#)
- Relay 2 – Latch / HOLD (1234#5#)
- Relay 2 – Unlatch / UNHOLD (1234#6#)

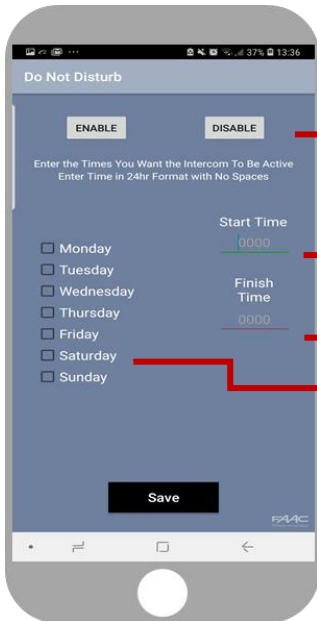

Do Not Disturb

Use this screen to set the ACTIVE time for the call button. Any button press outside of these times will be ignored by the intercom.

- Quick enable / disable button
- Set start and end time for button active times (24hr format, no colon). E.g. 8.30am = 0830.
- Set the days in which calls should be received, and do not select days which calls should be ignored.

9999#21#day.day.day#time1,time2#

Pass code Function code Enter start and end time in 24hr 4 digit format (no colon), and separate with comma. e.g. 0800,2300

Select days (up to 7)
3 digit format, separate with commas.
E.g. mon,tue,wed,thu,fri

To activate, enter the following code:
1234#21#ON# (change ON to OFF to disable again).

Out of Hours / After Hours

The number stored in this screen will receive calls from the intercom after hours if the do not disturb feature is set. This is useful for commercial installs to call a manager after normal business hours.



Enter phone number to receive out of hours calls

Enter button number (enter 1 for 1 button unit)

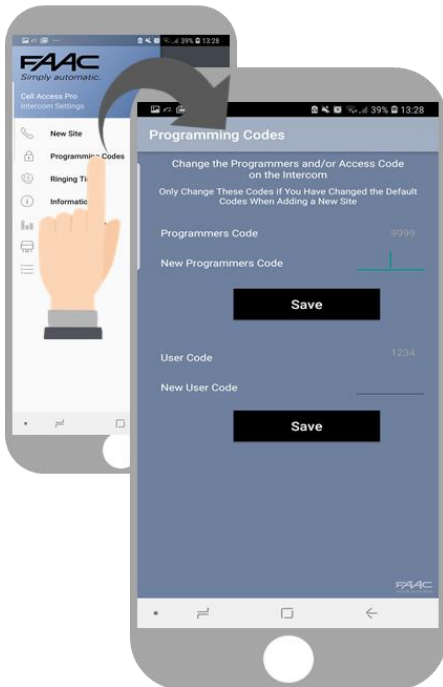
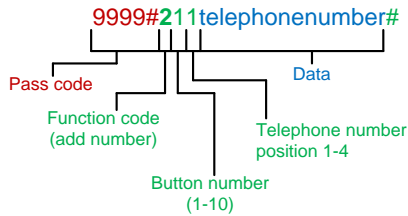

Programming codes

There are 2 main SMS programming pass codes on the intercom. One for the installer (default 9999), and the other for the user/homeowner (default 1234). It is advised to change these from the defaults in order to help maintain property security. **Note, user and programmer code cannot be the same as each other.**

If changing default codes, then you will now need to update the client list before you can do any further programming.

If the 1234 user access code is changed, then you will also need to change it on the home owners app.

SMS Strings:

9999#01XXXX# (X=new programmers code)

9999#02XXXX# (X=new user access code)

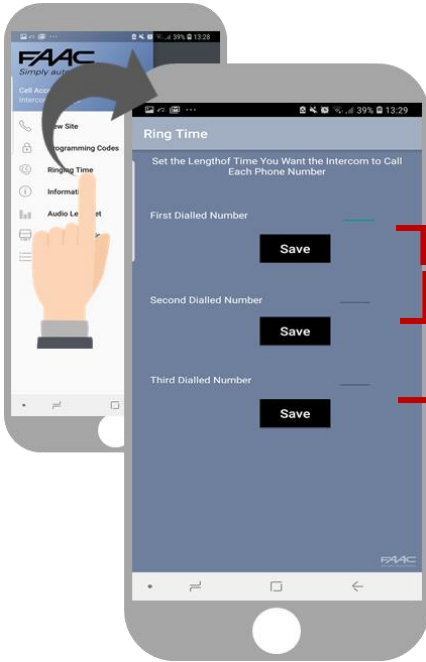

Ringing Times

In order to prevent unanswered calls going to voicemail (which will prevent the intercom rolling to then next phone number), you can adjust the ringing time to end the call before voicemail is picked up.

Enter time in seconds (1-99, default = 20)

SMS strings:

- 9999#45XX# (X=dialling time for first number)
- 9999#46XX# (X=dialling time for second number)
- 9999#47XX# (X=dialling time for third number)
- 9999#53XX# (X= talking time in seconds, 9999 max)

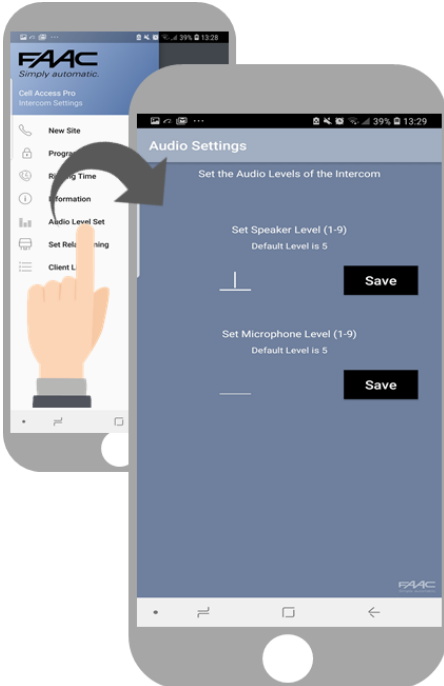

Volumes

Adjust microphone and speaker volumes (1-9, default = 5).

If your customer experiences high levels of echo on their phone when speaking to the gate, try reducing the microphone sensitivity as much as possible and also reduce the speaker volume if possible.

SMS string for Speaker Volume:
9999#3X# (X=1-9, default = 5)

SMS string for Microphone Volume:
9999#4X# (X=1-9, default = 5)

Information

This screen is very useful for retrieving information from the intercom and its status. E.g. keypad codes, or state of the relays.

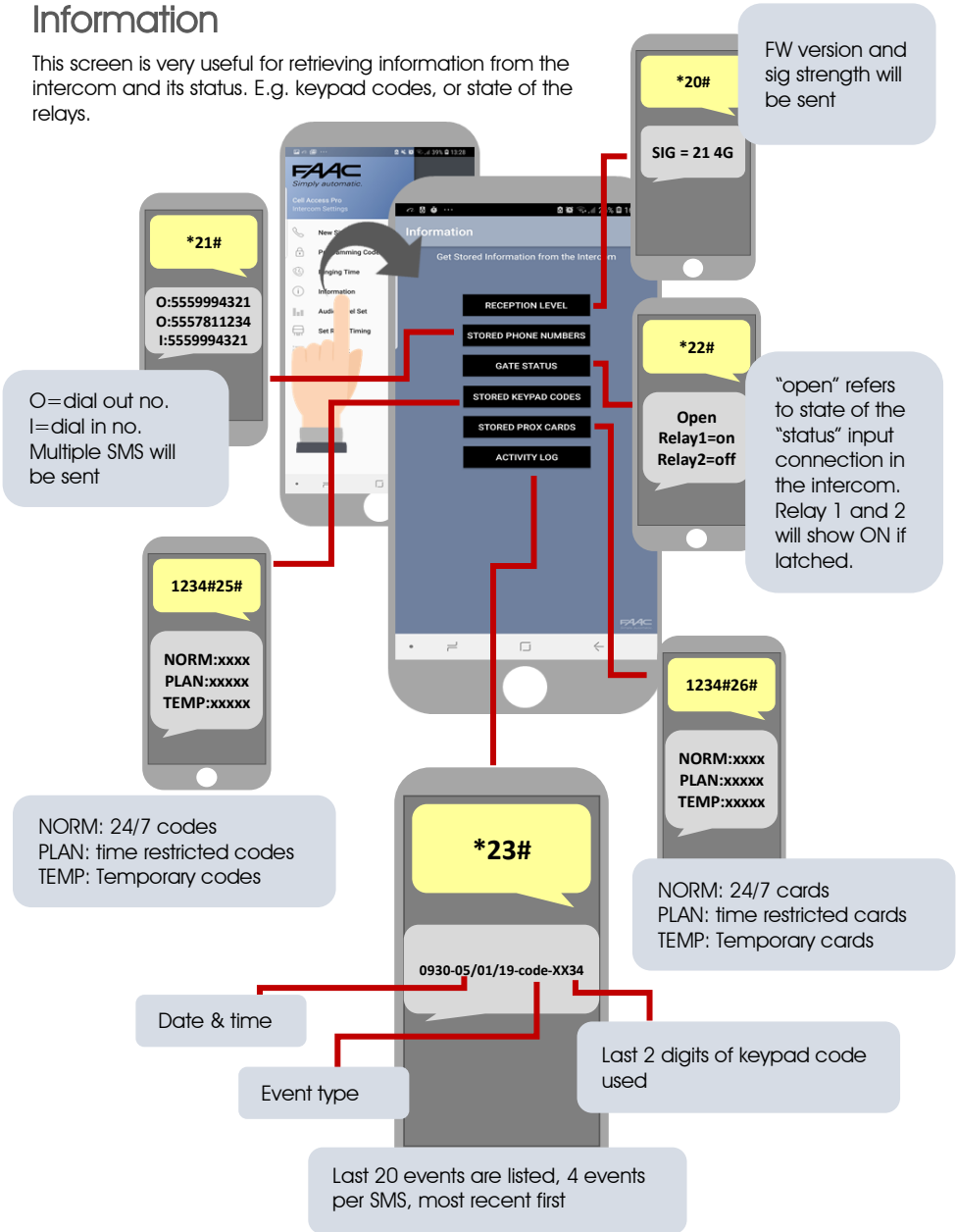

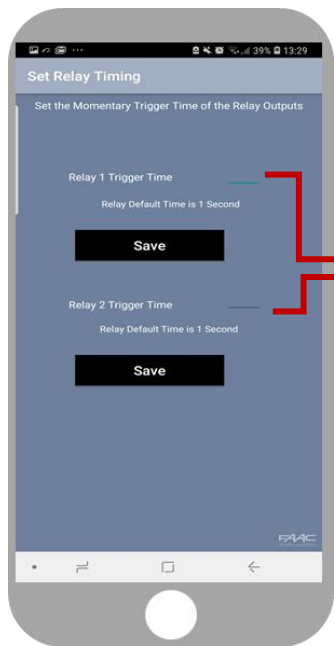

Relay Times

Relay default trigger times are 1 second. Use this feature to change a relay for a longer time perhaps for a magnetic door lock or to make one relay a momentary relay and the other a 1 hour relay for example.

Enter time in seconds (1-9999)

SMS string for relay 1 :

9999#50XXXX# (X=time in seconds, 1-9999)

SMS string for relay 2 :

9999#51XXXX# (X=time in seconds, 1-9999)

Complete list of parameters

The table below show the complete list of features. *Programming messages below must begin with 9999# (assuming 9999 is still the programming passcode)...*

Changing pass codes

9999#01????#	Change programming password	9999
9999#02????#	Change access control password (SMS control of relays, or non-stored numbers can call intercom & enter code to activate output 1).	1234
9999#03????#	Change monitoring mode password (user can call the intercom, enter this pass code to listen in and speak)	5555

Dial out numbers

9999#1XY????#	Store dialling out numbers. (X = button number 1-9 & 0 for button 10) (Y = number dialled 1-4) (???? = phone number)	N/A
9999#1XY*#	Delete a dial out number. (X = button number) (Y = number position 1-4)	N/A

Volume controls

9999#3?#	Speaker volume. Where ? = 1-9. 1 = lowest, 9 = highest.	5
9999#4?#	Microphone volume. Where ? = 1-9. 1 = lowest, 9 = highest.	5

Timings

9999#50?#	Relay 1 time. ? = seconds, 1-9999	1 sec
9999#51?#	Relay 2 time. ? = seconds, 1-9999.	1 sec
9999#45??#	Calling time for first number, adjust this to avoid voicemail picking up a call (10-99 secs)	20 secs
9999#46??#	Calling time for second number, adjust this to avoid voicemail picking up a call (10-99 secs)	20 secs
9999#47??#	Calling time for third number, adjust this to avoid voicemail picking up a call (10-99 secs)	20 secs
9999#53????#	Talking time. 5-9999 seconds.	60 secs
9999#55?#	Max monitoring time (for listen in mode when calling the intercom) 00-60 mins. 00 = no limit.	10 mins

Scheduled service calls

9999# 77number#	Store a service number to receive a scheduled call or SMS from the unit. Useful for SIM cards which are not often used to prevent switch off by the network provider.	N/A
9999#57??#	Set the time schedule for the intercom to make a scheduled call or SMS to the service number. 00-60 day time schedule. 00 = no call or SMS.	00
9999#58?#	Choose between making a scheduled call or scheduled SMS. 1 = SMS. 2 = call.	1
9999#77*#	Delete the stored service number	N/A

Caller ID features

9999# 72number#	Store caller ID number. Max 14 digits. Only last 6 digits compared.	N/A
9999# 73number#	Delete caller ID number.	N/A
9999#73*#	Delete all caller ID numbers	N/A

Service & diagnostic messages (no passcode required for some of these!)

*20#	Check reception level 1-31 (no passcode needed)	N/A
*21#	Check stored numbers. O = dial out number. I = dial in number. E = end of message. (no passcode needed)	N/A
*22#	Check input status and relay status. (No passcode needed)	N/A
*23#	Sends SMS messages of the last 20 events.	N/A
1234#25#	Check stored keypad codes.	N/A

Keypad Programming

9999# 81Xcode#time#	Permanent codes - X=1 or 2 for relay 1 or 2. Code = 4-6 digits. Time = 1-9999 seconds, or 0 for latching code.	N/A
9999# 83#day,day,day #time1,time2# code#	Time restricted codes Day = day of the week e.g. mon,tue,wed,thur,fri. Time1 = start time. Time2 = end time (24 hr format, no colon. E.g. 11:30pm = 2330. 8.30am = 0830. Code = pin code 4-6 digits.	N/A
9999# 82#hours#	Temporary codes Hours = time to expire in hours (1-168 hours).	N/A

code#	Code = Pin code 4-6 digit code.	
9999#84code#	Delete code – Code=known code to be deleted.	N/A
9999#84*#	Delete all codes.	N/A

Notifications

9999#80X#	X=1 to disable. X=2 to enable.	N/A
9999#78XXX#	X=phone number to send notifications to. (*=delete number)	N/A
9999#79text#	X=text to send to the receiving phone e.g. "gate opened"	N/A

Automatic Time Clock Trigger Times

1234#X# day,day,day# time#	X=1,2,3 (trigger, latch, unlatch relay 1) 4,5,6 (relay 2) Day = days of the week (mon,tue,wed,thur,fri,sat,sun) Time = time of day (24 hr format, no colon. E.g. 8:30am = 0830)	N/A
1234*X#	Delete ALL automatic trigger times.	N/A

Clock Sync - Auto Time Calibration after Power Fail

9999#86XXX#	X=telephone number of SIM inside the intercom.	N/A
9999#86*#	Delete the phone number.	N/A

Summer Daylight Auto Correct

9999#87??#	?? = number of days between SMS calibration SMS should be sent. 0 = no message sending.	N/A
------------	---	-----

Do Not Disturb (push button de-activated during set times)

1234#21#ON#	ON = activated. OFF = de-activated.	OFF
9999# 21#day,day,day #time1,time2#	Enter all active days during which button should operate. Enter start and end time button should operate (24 hr format, no colon. E.G 8:30am = 0830)	N/A

Alternate Number to Call During Do Not Disturb Times.

9999# 21X????#	X = button number (1-9. Enter 1 for 1 button system. Enter 0 for button 10) ???? = Alternative phone number to call out of hours.	
-------------------	--	--

Restore Defaults

9999#999#	Send with passcode string to clear all programming.	N/A
-----------	---	-----

Control by SMS

This intercom allows the user to send SMS commands to control the relays and check status as follows...

1234#1# - Relay 1 momentary trigger.
1234#2# - Relay 1 latch ON or hold ON.
1234#3# - Relay 1 unlatch or switch OFF.

1234#4# - Relay 2 momentary trigger.
1234#5# - Relay 2 latch ON or hold ON.
1234#6# - Relay 2 unlatch or switch OFF.

Troubleshooting guide

Q. The unit will not power up. No LEDs on.

A. Check power supply voltage at intercom is within 14.8V DC. Cable length from PSU to intercom should be less than 25 feet and in 14 gauge. Check the fuse.

Q. The unit powers up but is not showing network reception or will not respond to SMS.

A. This means the unit is not able to detect the network for some reason.

- Power off the unit, remove the SIM and check it in a mobile phone to verify it can make a call and has calling credit.
- Disable any PIN code request if active on the SIM card.
- Check the SIM is a standard voice capable SIM. If you are unsure, contact your SIM card provider to verify. Compatible networks are At&T and T-Mobile.
- Check the reception is medium or good. Poor reception is not sufficient.
- Power off, remove the SIM, use fine sand paper to lightly sand the SIM pads and contacts on the GSM unit, lightly bend the contacts upwards so that they make better contact with the SIM and try again.

Q. The unit calls the first number, but there is not enough time to answer before it diverts to the next number.

A. Increase the no answer time as per programming instructions.

Q. The unit calls the first number but voicemail comes on before it can ring the second number.

A. Decrease the no answer time as per programming instructions.

Q. The caller ID part does not work.

A. Be sure to program the caller ID part under 72 feature. If your number is a private or number withheld, then it will not work.

- Even if you have already programmed a number to receive a call from the intercom, if you also want that number to have caller ID access, it must be programmed under the 72 feature also.
- Ensure the number is entered as you would normally dial it from another phone.
- For US customers, ensure the numbers have been entered with a leading 1. If this does not work, try again without the leading 1.

Q. There is no audio from the gate, but the person at the gate can hear ok.

A. This can be due to low reception or excessively long power cables.

- Check reception level by *20#.
- Change SIM card if necessary to another network which may have better coverage.
- Purchase a high gain antenna.

This may also be caused by a defective microphone, water on a microphone from a sprinkler for example, or dirt/insects blocking the microphone hole. If reception is optimum and the problem persists, contact your supplier or installer.

Q. The audio quality that can be heard on the remote telephone is poor or humming (buzzing).

A. A small amount of GSM buzz can be considered normal on GSM intercoms, but not so much that causes inability to hear the person speaking. This is a symptom of poor reception. Try above steps on checking and improving reception. Consider fitting an external high gain antenna.

Q. The trigger keys do not work when the Intercom calls a phone.

A. Check if you can hear the relay clicking at the gate when the keys are pressed during a call. If it can be heard, then the system is working, check wiring between the relay and the lock or gate panel. If the relays do not make a clicking sound, then check this feature on a different mobile cell phone or landline. If it works on a different phone, check the settings on the phone in question under DTMF tones.

Failure of DTMF tones to operate correctly is also a symptom of low reception or insufficient power cabling. Check steps above on improving reception or addressing the power problem.

-Also check that the relays are not already latched with the *22# command. If they are latched, they need unlatched before the trigger keys will work.

-Sometimes excessively long power cables or thin power cables can cause this problem. Prove it by connecting a temporary extension lead and the power supply directly to the unit.

Q. The system was operating the gates fine, but now it will not trigger the gates.

Frequently, this is cause by the user accidentally latching the relay. This latches the output relay permanently on. Send the intercom the following SMS *22#. The intercom should reply with a message detailing the relay status.. If it has been latched, then the message will state "the relay is ON". In this case refer to the user guide to read how to unlatch it again.

Q. The unit no longer calls out to phones but I can make a call to it from my phone.

A – Check there is balance on the SIM card.

A – Switch off the power, remove the SIM, put it into a phone, and check that a call can be made from a phone. This will verify if the SIM is still working and in service.

Q. The Android App shows an error message "Command Failed" when I try to use a function.

A – Go to phone settings/application manager/cellbox prime/permissions, and ensure all permissions are turned ON. Also ensure the app settings screen has a valid phone number stored.

Change History

Key:

P = Panel version H = Hardware PCB version S = Software version

Version			Reason for change	Date
P	H	S		

Warranty Terms

To the original purchaser only:

FAAC International, Inc., warrants, for twenty-four (24) months from the date of invoice, the gate operator systems and other related systems and equipment manufactured by FAAC S.p.A. and distributed by FAAC International, Inc., to be free from defects in material and workmanship under normal use and service for which it was intended provided it has been properly installed and operated.

FAAC International, Inc.'s obligations under this warranty shall be limited to the repair or exchange of any part of parts manufactured by FAAC S.p.A. and distributed by FAAC International, Inc. Defective products must be returned to FAAC International, Inc., freight prepaid by purchaser, within the warranty period. Items returned will be repaired or replaced, at FAAC International, Inc.'s option, upon an examination of the product by FAAC International, Inc., which discloses, to the satisfaction of FAAC International, Inc., that the item is defective. FAAC International, Inc. will return the warranted item freight prepaid. The products manufactured by FAAC S.p.A. and distributed by FAAC International, Inc., are not warranted to meet the specific requirements, if any, of safety codes of any particular state, municipality, or other jurisdiction, and neither FAAC S.p.A. or FAAC International, Inc., assume any risk or liability whatsoever resulting from the use thereof, whether used singly or in combination with other machines or apparatus.

Any products and parts not manufactured by FAAC S.p.A. and distributed by FAAC International, Inc., will carry only the warranty, if any, of the manufacturer. This warranty shall not apply to any products or parts thereof which have been repaired or altered, without FAAC International, Inc.'s written consent, outside of FAAC International, Inc.'s workshop, or altered in any way so as, in the judgment of FAAC International, Inc., to affect adversely the stability or reliability of the product(s) or has been subject to misuse, negligence, or accident, or has not been operated in accordance with FAAC International, Inc.'s or FAAC S.p.A.'s instructions or has been operated under conditions more severe than, or otherwise exceeding, those set forth in the specifications for such product(s). Neither FAAC S.p.A. nor FAAC International, Inc., shall be liable for any loss or damage whatsoever resulting, directly or indirectly, from the use or loss of use of the product(s). Without limiting the foregoing, this exclusion from liability embraces a purchaser's expenses for downtime or for making up downtime, damages for which the purchaser may be liable to other persons, damages to property, and injury to or death of any persons.

FAAC S.p.A. or FAAC International, Inc., neither assumes nor authorizes any person to assume for them any other liability in connection with the sale or use of the products of FAAC S.p.A. or FAAC International, Inc. The warranty herein above set forth shall not be deemed to cover maintenance parts, including, but not limited to, hydraulic oil, filters, or the like. No agreement to replace or repair shall constitute an admission by FAAC S.p.A. or FAAC International, Inc., of any legal responsibility to effect such replacement, to make such repair, or otherwise. This limited warranty extends only to wholesale customers who buy directly through FAAC International, Inc.'s normal distribution channels. FAAC International, Inc., does not warrant its products to end consumers.

Consumers must inquire from their selling dealer as to the nature and extent of that dealer's warranty, if any. This warranty is expressly in lieu of all other warranties expressed or implied including the warranties of merchantability and fitness for use. This warranty shall not apply to products or any part thereof which have been subject to accident, negligence, alteration, abuse, or misuse or if damage was due to improper installation or use of improper power source, or if damage was caused by fire, flood, lightning, electrical power surge, explosion, wind storm, hail, aircraft or vehicles, vandalism, riot or civil commotion, or acts of God.

Regulatory Compliance

FCC Id: 2ALPX-PE-4GA

(Multiple variation part numbers registered under this main part number)

Grantee: Advanced Electronic Solutions Global LLC

This device complies with Part 15 of FCC rules. Operation is subject to the following two conditions: (1) this device may not cause harmful interference, and (2) this device must accept any interference received, including interference that may cause undesired operation.

Output power listed is ERP below 1GHz for Part 22 and EIRP above 1GHz for Part 24. RF exposure compliance is addressed for 1.1310 and 2.1091 MPE limits. The antenna(s) used for this transmitter must be installed to provide a separation distance of at least 20 cm from all persons. End Users must be provided with transmitter operation conditions for satisfying RF exposure compliance.



Note: For legal reasons, telephone technical support is for registered and qualified product dealers only. Home owners and end users should contact their local dealer for product technical support